



Pro-Bel Group Ltd.
765 Westney Road South
Ajax, Ontario, Canada L1S 6W1

Toll Free: (800) 461-0575
Tel: (905)-427-0616
Fax: (905)-427-2545
Email: info@pro-belgroup.com

NOTES:

1. SYSTEM GOOD FOR 1,000 lbs WORKING LOAD ONLY.
2. PRO-BEL STANDARD MONORAIL SHOWN WITH TELESCOPIC HANGER BRACKET ASSEMBLY (TYPE 3) BOLTED THROUGH EXISTING CONCRETE SLAB USING A 4 SETS OF HARDWARE PACKAGE C/W BACK PLATES.
3. SEE MONORAIL CATALOG FOR MORE DETAILS ON PRO-BEL MONORAIL SYSTEM, INCLUDING OTHER AVAILABLE ACCESSORIES.

IMPORTANT:

1. IT IS THE RESPONSIBILITY OF THE STRUCTURAL ENGINEER FOR THE OVERALL PROJECT TO ENSURE THAT THE STRUCTURE ON WHICH THE SAFETY EQUIPMENT BY PRO-BEL IS INSTALLED, IS REINFORCED TO WITHSTAND THE LOADS INDICATED ON THIS DRAWING.

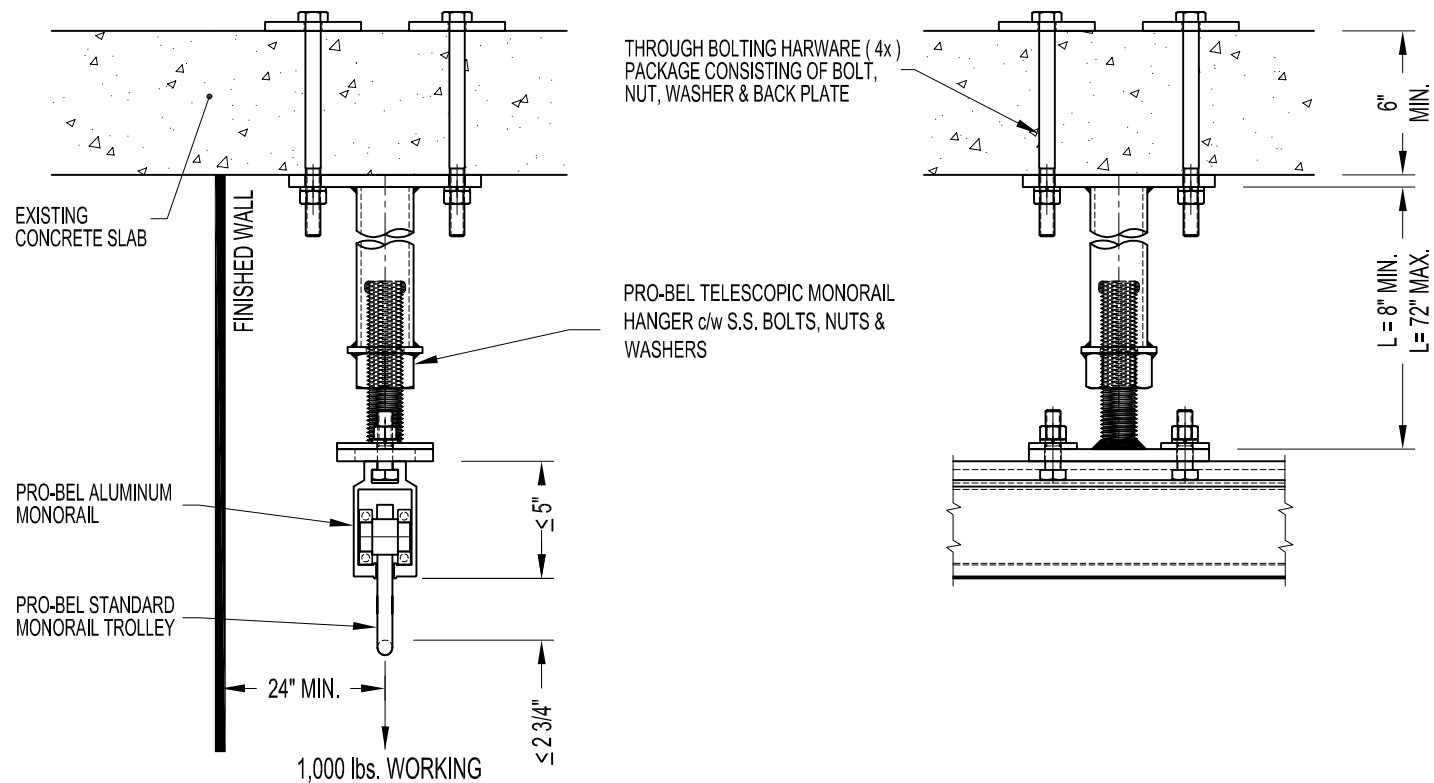

MNH310-7200: PRO-BEL MONORAIL HANGER BRACKET ASSEMBLY TYPE 3 - (THROUGH BOLTED)